

RADIANTE 747 STANDARD INSTALLATION

LEGEND

- Firebox Dimension
 - ▲ Exact Dimension
 - Minimum Dimension
 - ➔ Air Intake
 - ⇨ Air Outlet
- Brick Masonry

NOTES:

- [1] Air intake grilles minimum air flow area required = 180cm² each side.
- [2] Air outlet grilles minimum air flow area = 240cm² each side and 480cm² if one grille is used.
- [3] Hearth height dimensions optional (Refer to Technical Data & Installation Instructions)
- [4] All dimensions in millimetres.
- [5] Heater can be left freestanding.
- [6] Do not scale from these diagrams
- [7] Air transfer kits mandatory for exempt units to comply to AS/NZ 4012/4013:2014. Fan optional depending on duct length. (Refer to Technical Data & Installation Instructions)

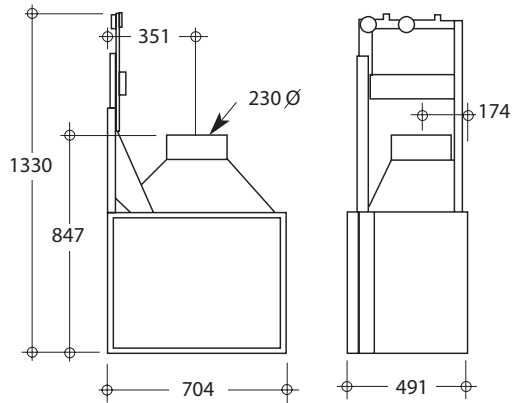

FIREPLACE CONSTRUCTION STEP 1

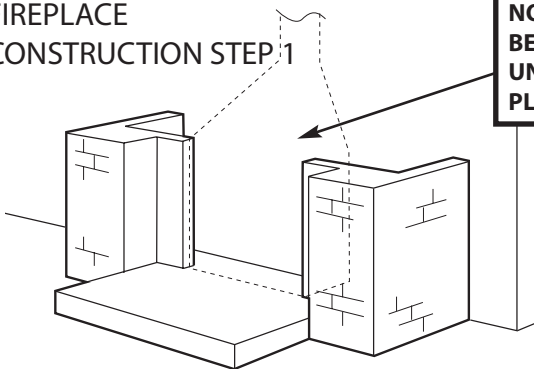

**IMPORTANT:
NO BRICKWORK TO
BE COMMENCED
UNTIL FIREBOX IS
PLACED IN POSITION**

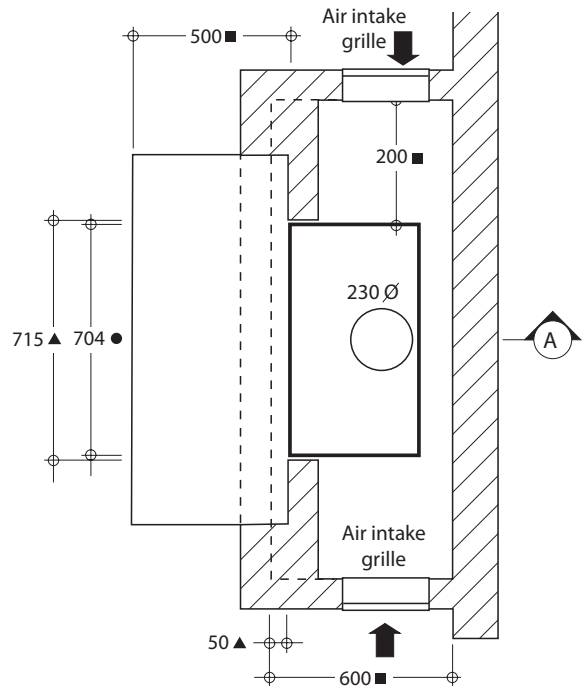

FIREPLACE CONSTRUCTION STEP 2

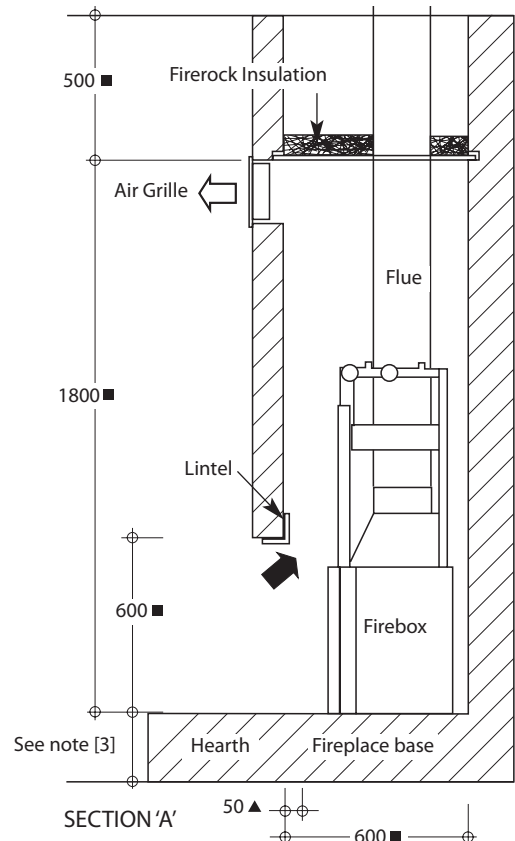
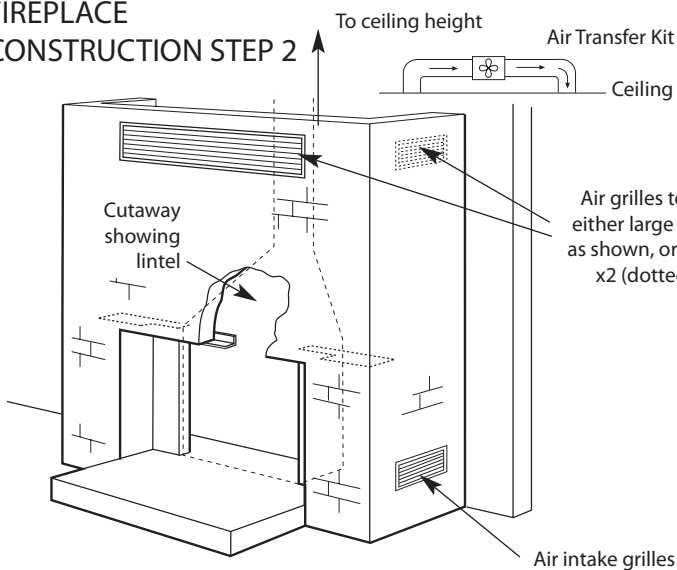

**CHEMINÉES
PHILIPPE
AUSTRALIA**

430 Johnston St., Abbotsford, Victoria 3067 Phone: 03 9417 3315
e-mail: sales@wignells.com.au www.chemphilaustralia.com.au