



GODIN PROMES COOKER



The Promes slow combustion stove offers real versatility for the most discerning cook. A generous, solidly built, cast iron oven provides a constant and efficient heat, the spacious cook top offers ample space for the largest pots and a roomy storage drawer for cooking utensils. The Promes boasts two fabulous, large glass doors allowing you to enjoy the flames in the wood box and monitor your cooking in the oven. With this beautiful stove you'll enjoy all the comforts of home in the timeless tradition of a Godin creation.



HEAT OUTPUT
>160sqm*



CLEAN
BURNING



CAST IRON &
STEEL CONSTRUCTION

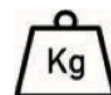

WEIGHT
163kg



FLUE SIZE
150mm or 6"

PROMES COOKER

DIMENSIONS

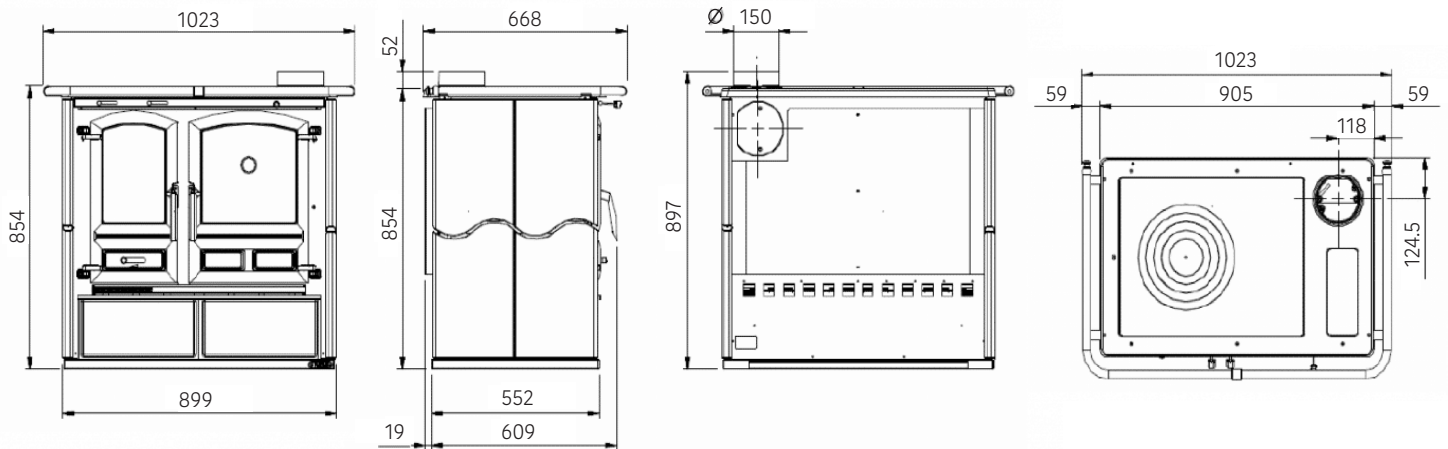

CLEARANCES

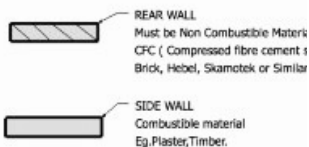

COMPLIES TO AUSTRALIAN STANDARDS: AS2918
REAR WALL: to be non combustible material,
 CFC compressed fibre cement sheet, brick, hebel, skamotek
 or similar materials
SIDE WALL: 150mm to combustible wall, 50mm
 if shielded with Non Combustible materials
REAR WALL : Shielded wall 25mm from Non Combustible
 required at rear of cooker. Fireproof cement sheet or oth
HEARTH: Minimum 6mm CFC & Stone, Tiles cover

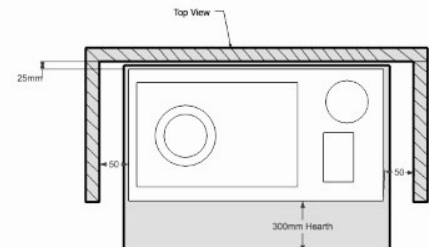
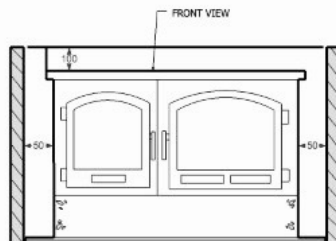
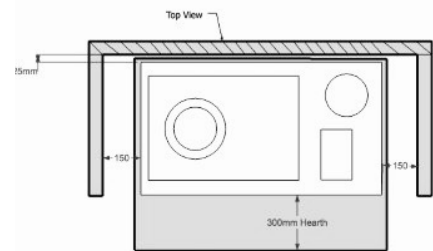
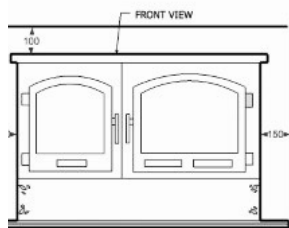

IMPORTANT

This appliance and flue kit is to be strictly installed in accordance with AS/NZS 2918:2018 and the appropriate requirements of the installation manual and building codes. It also **MUST** be installed by a licensed and qualified trades professional.

*Heating capacity fluctuates depending on ceiling heights, installation, operation and place of construction